



Installation & Operation Manual ►

GROWATT NEW ENERGY CO.,LTD

No. 12 Building, Xicheng Industrial
Zone, Bao'an District, Shenzhen, P. R.China

T + 86 755 2747 1900

F + 86 755 2749 1460

E service@ginverter.com

W www.ginverter.com

Congratulations on choosing our Grid PV Inverter. Our Grid PV Inverters are highly reliable products due to their innovative design and perfect quality control. Such inverters are used in high demand, grid-linked PV systems. This manual contains important information regarding installation and safe operation of this unit. Be sure to read this manual carefully before using. If you encounter any problems during installation or operation of this unit, first check this manual before contacting your local dealer or representative. Instructions inside this manual will help you solve most installation and operation difficulties.

1 CONTRNT

2 INSTALLATION

- 2.1 Installation manual
- 2.2 Fixed on the wall
- 2.3 Connect to the grid (AC utility)
- 2.4 Connect to PV panel (DC input)
- 2.5 Checking
- 2.6 System diagram

3 MODES OF OPERATION

- 3.1 Normal mode
- 3.2 Fault mode
- 3.3 Shutdown mode
- 3.4 Sound control LCD display

4 INVERTER STATUS

5 COMMUNICATIONS

- 5.1 Communications software instructions
- 5.2 Monitor
- 5.3 Detailed information
- 5.4 RS 485 cable connection

6 TROUBLE SHOOTING

7 SPECIFICATIONS

Design Overview

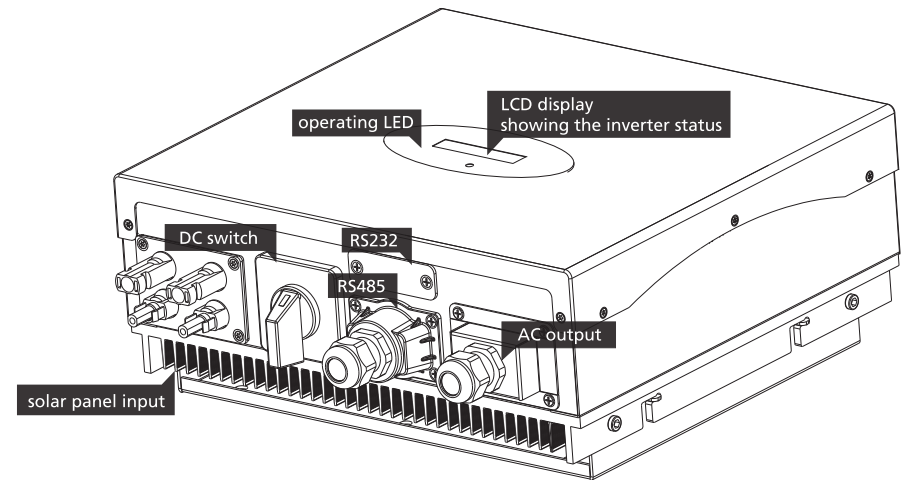

Front Overview

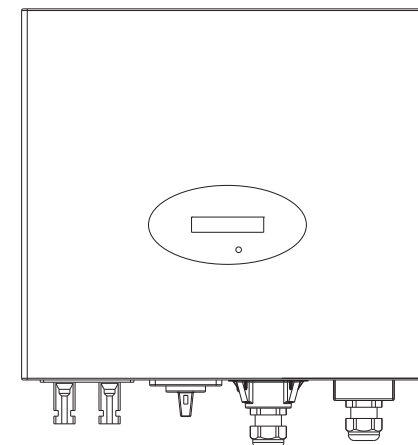

Bottom Overview

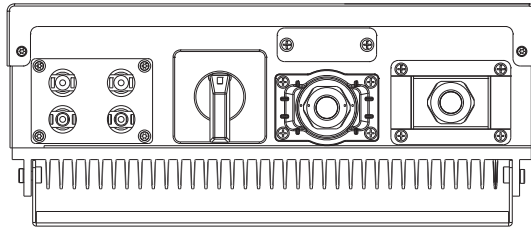

Opening the package

After opening the package, please check the contents of the box. It should contain the following:

Item	Name	Quantity
1	Solar inverter	1
2	Mounting frame	1
3	Mounting screws	6
4	Safety-lock screws	4
5	Mounting frame screws sleeve	6
6	AC socket	1
7	AC socket assembly screws	4
8	Installation & Operation manual	1
9	RS485 waterproof device	1
10	RS485 waterproof device assembly screw	4

2.1 Installation manual



- A** Do not remove the casing. Inverter contains no user serviceable parts. Refer servicing to qualified service personal. All wiring and electrical installation should be conducted by a qualified service personnel and must meet national requirements of AS/NZS 3000.
- B** Both AC and DC voltage sources are terminated inside the PV Inverter. Please disconnect these circuits before servicing.
- C** When a photovoltaic panel is exposed to light, it generates a DC voltage. When connected to this equipment, a photovoltaic panel will charge the DC link capacitors.
- D** Energy stored in this equipment's DC link capacitors presents a risk of electric shock. Even after the unit is disconnected from the grid and photovoltaic panels, high voltages may still exist inside the PV-Inverter. Do not remove the casing until at least 10 minutes after disconnecting all power sources.
- E** This unit is designed to feed power to the public power to the public grid (utility) only. Do not connect this unit to an AC source or generator. Connecting Inverter to external devices could result in serious damage to your equipment.
- F** Carefully remove the unit from its packing and inspect for external damage. If you find any imperfections, please contact your local dealer.
- G** Although designed to meet all safety requirements, some parts and surfaces of Inverter are still hot during operation. To reduce the risk of injury, do not touch the heat sink at the back of the PV-Inverter or nearby surfaces while Inverter is operating.

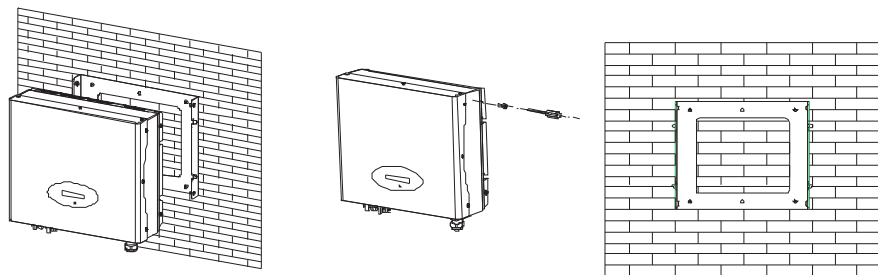

Image 1

Image 2

Image 3

2.2 Fixed on the wall

- A** Select a wall or solid vertical surface that can support the PV-Inverter.
- B** Inverter requires adequate cooling space. Allow at least 20cm space above and below the inverter.
- C** Using the mounting frame as a template, drill 4 holes as illustrated in image 1+2.
- D** Fix the mounting frame as the figure shows. Do not make the screws to be flush to the wall. Instead, leave 2 to 4mm exposed.
- E** Hang the inverter on the mounting frame.
- F** Check the installation conditions.

- ▶ Do not install the PV-Inverter on a slanted surface.
- ▶ Check the upper straps of PV-Inverter and ensure it fits on to the bracket.
- ▶ Insert safety-lock screws to the bottom leg to secure the inverter (image 3).
- ▶ Check the secure mounting of the PV-Inverter by trying to raise it from the bottom. The PV-Inverter should remain firmly attached.
- ▶ Select the installation location so that the status display can be easily viewed.
- ▶ Choose a strong mounting wall to prevent vibrations while inverter is operating

2.3 Connect to the grid (AC utility)

- A** Measure the grid (utility) voltage and frequency. It should be 230 VAC (or 220VAC), 50/60Hz and single phase.
- B** Open the breaker or fuse between PV Inverter and utility.
- C** For Inverter, AC wires specifications as follows:

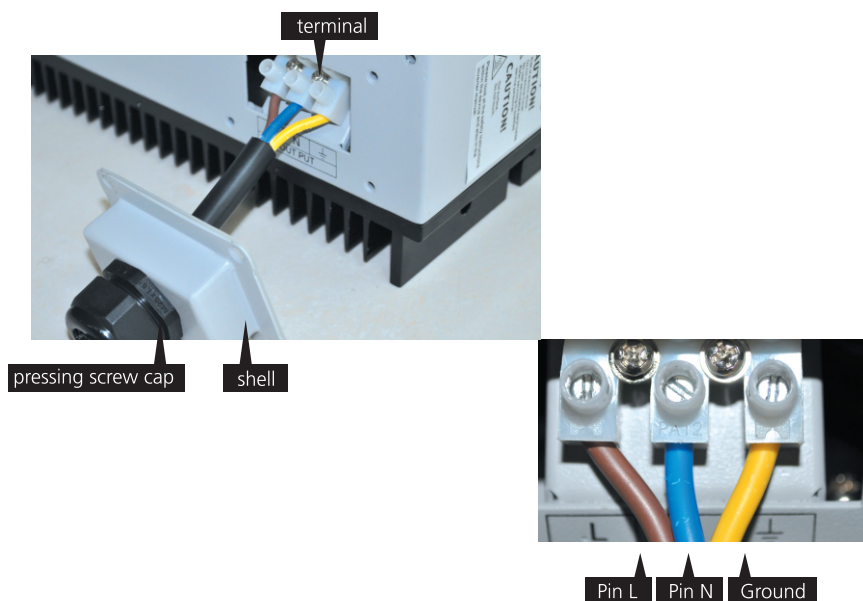

Model	_ (mm)	Area(mm ²)	AWG no.
Growatt 1000-3000	2.05	3.332	12
Growatt 4000-5000	2.59	5.26	10
Sungold 1000-3000	2.05	3.332	12
Sungold 4600-5000	2.59	5.26	10

2.4 Connect to PV panel (DC input)

A

under any condition! Make sure the maximum open circuit voltage (Voc) of each PV string is less than 580 VDC for Growatt 4000, Growatt 4400, Growatt 5000, Sungold 4600, Sungold 5000, less than 500 VDC for Growatt 2000, Growatt 3000, Sungold 2000, Sungold 3000, and less than 450 VDC for Growatt 1500, Growatt 1000, Sunglod 1500, Sunglod 1000, The length of input wire must be less than 30m.

B

Use H4 or MC4 (Multi-contact) connectors for PV array terminals. Make sure DC switch is off before connecting.

C

Connect the positive negative terminals from the PV panel to positive (+) terminals and negative (-) terminals on the PV-Inverter. Each DC terminal on Inverter can withstand 20ADC.

D

Before connecting PV panels to DC terminals, please make sure the polarity is correct. Incorrect polarity connection could permanently damage the unit. Checks short-circuit current of the PV string. The total short-circuit current of the PV string should be less than the inverter's maximum DC current.

E

High voltages exist when the PV panel is exposed to the sun. To reduce risk of electric shock, avoid touching live components and treat connection terminals carefully.

2.5 Checking

2.5.1 Country selecting

When the PV panels are connected and their output voltage is greater than 100Vdc but the AC grid is not yet connected, inverter will start up automatically. If it is the first time to power on the inverter after installation, you may need to select a specific country*. Otherwise, the interface will stay at the 'Please Select' interface all the time. There are eleven options to select, as the list below.

* If you have ordered the inverter with specific country settings, the parameters have been preset in factory and you don't need to operate this step any more.

Country/Regulation Name	options
VDE0126-1-1	// 0
Germany	// 1
UK_G83	// 2
Italy	// 3
France	// 4
Denmark	// 5
Belgium	// 6
Spain	// 7
Greece	// 8
Turkey	// 9
Hungary	// 10

Note: 1. If the country you want to select is not in the above list, please directly select VDE0126-1-1.

2. The inverter can only be used for single grid-connected in the area where CEI 0-21 and VDE-AR-N4105 are requested to accord.

Please finish the country selecting according to the following steps:

A

The LCD will quickly switch to and stay at the 'Please select' interface after power on, as Fig 2-5-1.

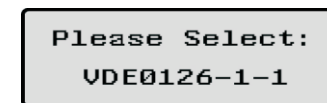

Fig 2-5-1

B

Single knock on the LCD, countries will vary from one to another along the above list order. Fig 2-5-2 acts as an example, and Germany is the second selection.

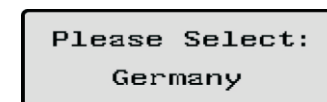

Fig 2-5-2

C When you need to select any of these countries, you can Double knock to enter the next interface. Here we select Italy as an example, as Fig 2-5-3.

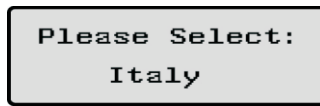

Fig 2-5-3

D When the country arrives at Italy, Double knock to enter the two options 'YES' and 'NO', and the cursor stays at 'NO' in default, as Fig 2-5-4.



Fig 2-5-4

E Single knock to select 'YES', as Fig 2-5-5.



Fig 2-5-5

F Double knock to confirm your selection, LCD will display 'Select OK' with the country name in the below, as Fig 2-5-6.

Note: if you still single knock at the interface as Fig 2-5-5, the cursor will go to 'NO' again as Fig 2-5-4, then if you double knock, the display will switch to the interface as Fig 2-5-3.

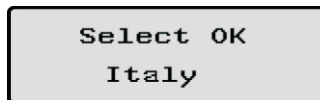

Fig 2-5-6

G When the selection is successful, the inverter will reboot automatically.

Note: If you have selected and confirmed an unwanted country neglectful, please contact Growatt for specific software to clear and reset again.

2.5.2 Commissioning

- ▶ After the inverter reboot, LCD will produce the following messages in order: 'Ser NO: xxx'->'xxxxx'->'FW version'->'Waiting'->'No AC connection', the display repeats 'NO Utility' and LED will be red.
- ▶ Close the AC breaker or fuse between PV-Inverter and grid. Turn on the DC switch. The normal operating sequence begins.
- ▶ Under normal operating conditions the LCD displays 'Power: xxx.x W'. That is the power fed to the grid. The LED turns green.
- ▶ This completes the check.

2.6 System diagram

A PV Panel: Provide DC power to inverter.

B Converts DC (Direct Current) power from PV panel (s) to AC (Alternating Current) power. Because Inverter is grid-connected it controls the current amplitude according to the PV Panel power supply. Inverter always tries to convert the maximum power from your PV panel(s).

C Connection system : This "interface" between Utility and PV-Inverter may consist of electrical breaker, fuse and connecting terminals. To comply with local safety standards and codes, the connection system should be designed and implemented by a qualified technician.

D Utility: Referred to as "grid" in this manual, is the way your electric power company provides power to your place. Please note that Inverter can only connect to low-voltage systems (namely, 220_230VAC, 50/60Hz).



3 Modes of Operation

There are 3 different modes of operation.

3.1 Normal mode

In this mode, Inverter works normally. Whenever the supplied power from PV panel is sufficient (voltage > 150VDC), Inverter converts power to the grid as generated by the PV panel. If the power is insufficient, (voltage < 100VDC) Inverter enters a "waiting" state. Whilst "waiting" Inverter uses just enough power from the PV panel to monitor internal system status. In normal mode the LED is green.

3.2 Fault mode

The internal intelligent controller can continuously monitor and adjust the system status. If Inverter finds any unexpected conditions such as grid problems or internal failure, it will display the information on its LCD and the LED will be red.

3.3 Shutdown mode

During periods of little or no sunlight, Inverter automatically stops running. In this mode, Inverter does not take any power from the grid. The display and LED's on the front panel do not work.

Notes

Operating inverter is quite easy. During normal operation, Inverter runs automatically with DC switch on. However, to achieve maximum conversion efficiency of Inverter please read the following information:

a Automatic ON-OFF:

With DC switch on, Inverter starts up automatically when DC-power from the PV panel is sufficient.

Once the PV - Inverter starts it enters one of the following 3 states:

1. Standby: The PV string can only provide just enough voltage to minimum requirements of the controller.
2. Waiting: When the PV string DC voltage is greater than 100V, Inverter enters a "waiting" state and attempts to connect to the grid.
3. Normal operation: When PV string DC voltage is greater than 150V, Inverter operates in the normal state.

b Starting-up display sequence:

Once the PV power is sufficient, Inverter displays information as shown in the flow chart as follow:

SerNo: xxxxxxxx Connect in xxS	Module: xxxxxxxx Connect OK	FW Version: x.x.x Power: xxxx.xW
-----------------------------------	--------------------------------	-------------------------------------

LCD backlight control:

To save power, the LCD display's backlight automatically turns off after 30 seconds.

The First line of LCD

STATE	DISPLAY	REMARK
Wait State	Standby	PV voltage low
	Waiting	Initial waiting
	Connect in xxS	System checking
	Reconnect in xxS	System checking
Inverter State	Connect OK	Connect to Grid
	Power: xxxx.xW	Inverter watt at working
Fault State	Error: xxx	System Fault
Auto Test State	Auto Testing	Protecting auto test
Program State	Programming	Update Software

The second line of LCD

SerNo	CYCLE DISPLAY	DISPLAY TIME/S	REMARK
1	Etoday: xx.x KWh	4	The energy today
2	Eall: xxx.x KWh	4	The total energy
3	Tall: xx.x h	4	The total work time
4	PV: xxx/xxx. B: xxx	4	The PV1 & PV2 voltage
5	AC: xxxV F: xx.xHz	4	The AC voltage and frequency
6	SerNo: xxxxxxxxxx	4	The serial number
7	Module: PX UX MX SX	4	The inverter module
8	FW version: x.x.x	4	The software version
9	Enable Auto Test	4	The enable auto test
10	Set Language	4	Set LCD language
11	Set LCD Contrast	4	Set LCD contrast
12	System F: XXHz	4	The grid frequency
13	COM address: xx	4	The communication Address

3.4 Sound control LCD display

The display on the inverter can be control by Knock on the front of it. Sound control can define the display language, luminance of the display, auto-test and frequency.

When the LCD is dark:

Knock and double knock make it becomes bright.

When the LCD is bright:

Knock to make it display next information or change the set situation.
Double knock make the display stand for 30 second on 1-5. And enter set menu on 6-12.

Set the display:

Set Queensland grid voltage range

Knock to make the display become bright -> Knock to item "Model: GTXXXXXX" -> Double knock to enter "Normal Volt range" -> Knock to change it to "Qld Vmax 255v" -> wait until the display become dark, then the inverter saved change.

Note: this function is only for Ergon Energy area, Queensland, Australia.

Set language

Knock to make the display bright -> knock to "set language" -> double knock to enter "language: English" -> knock to select the language you need and wait until the display become dark.

Set luminance of the display

Knock to make the display bright -> knock to "set LCD contrast" -> double knock to enter "LCD contrast 2" -> knock to select the luminance you need and wait until the display become dark.

Auto test

Knock to make the display bright -> knock to "Enable Auto test" -> double knock to enter "Waiting to start" -> knock to start auto test and wait for the test result.

Frequency

Knock to make the display bright -> knock to "System F: xxHz" -> double knock to enter "System F: xxHz" -> knock to select the Frequency you need and wait until the display become dark.

Set contrast

Knock to make the display bright -> knock to "COM Address: xx" -> double knock to change the Address mode -> knock to set address.

Inverter is designed to be user-friendly; therefore, the status of the Inverter can be easily understood by reading the information shown on the front panel display. All possible messages are shown in the following table.

DISPLAY	OPERATION
	System fault
Auto Test Failed	Auto test do not pass
No AC Connection	No utility, no grid connect
PV Isolation Low	Insulation problem
Residual I High	GFCI fault
Output High DCI	Output Current DC offset too high
PV Voltage High	PV panel voltage too high
AC V Outrange	Grid voltage out of range
AC F Outrange	Grid frequency out of range
	Inverter fault
Error: 100	2.5V Reference Voltage Fault
Error: 101	Communication Fault
Error: 102	Consistent Fault
Error: 116	EEPROM Fault
Error: 117	Relay Fault
Error: 118	Init Model Fault
Error: 119	GFCI Device Damage
Error: 120	HCT Fault
Error: 121	Communication Fault
Error: 122	Bus Voltage Fault

5 Communication

5.1 Communications software instructions

ShineNET is a PC software that communicates with Shine Inverter to analyze the inverter work state. It is convenient for you to know the inverter real time working state and the history work information.

Spec:

1. Communicate with inverter by RS232 and Bluetooth.
2. Construct net with inverter, GROmonitor and ShineNet by RS232, Bluetooth and Internet.
3. Two Interfaces: Multi Inverter Interface and Wave Data Interface.
4. In Multi Inverter Interface: 9 inverters working data at the same time, you can select your own compare inverters and parameters.
5. In Wave Data Interface: Query the inverter real time and history power wave, work data and error information.
6. Multi languages: English, Simple Chinese, French, German, Spanish and etc.
Support OS: WinXP / Vista / win7 / 2000 / 2003

5.2 Monitor

After setting the software the user can monitor the inverter. The right side of the main interface is the detailed information of inverter.

5.3 Detailed information

Detailed setting method and other functions refer to "ShineNET Manual." in the CD.

5.4 RS 485 cable connection

1. Please take out the RS485 waterproof device from the Accessories bag, even if you don't choose RS485 as communication method, the RS485 waterproof device still has to be locked on the inverter.

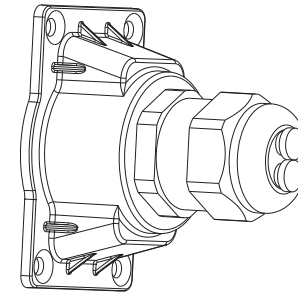

2. Twist off the waterproof connector, and pull out one or two Stopper according to your demand.

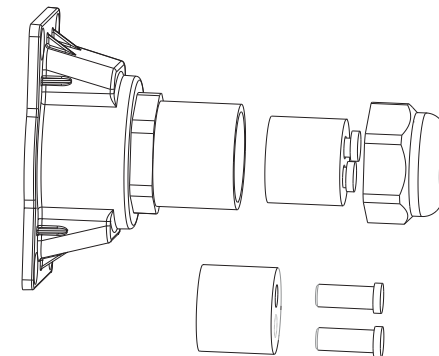

3. Make the cable through the hole of rubber stopper and the RS485 waterproof cover. The type of cable is recommended as "KVVRP22/2*1.5".

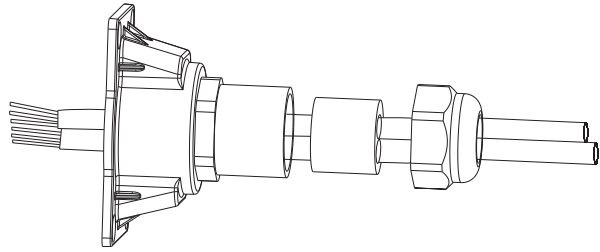

4. Take out the RS485 connection terminal.

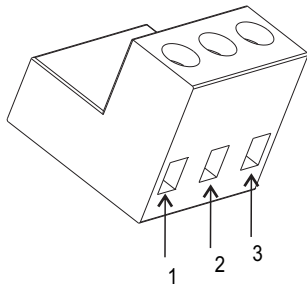

5. Connect the cable to the RS485 terminal ('1' to '1', '3' to '3', and '2' to the shielding net) → plug RS485 terminals into the inverter → tight waterproof connector → lock waterproof device onto the inverter.

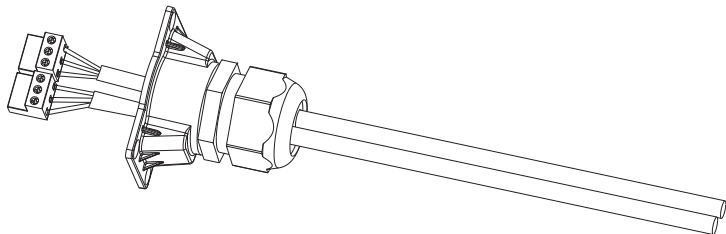

Note:

① As to the connection between inverters, please refer to the following figure.

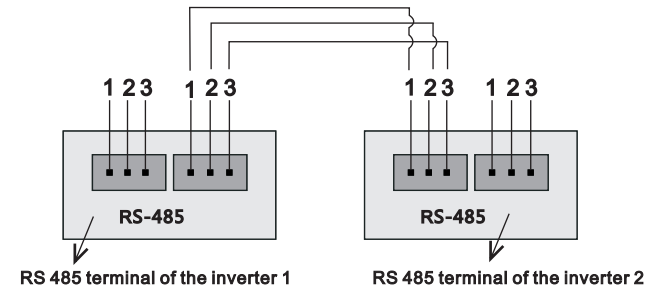

② As to the connection between inverter and Shine WebBox (or Shine Pano), please refer to the following figure.

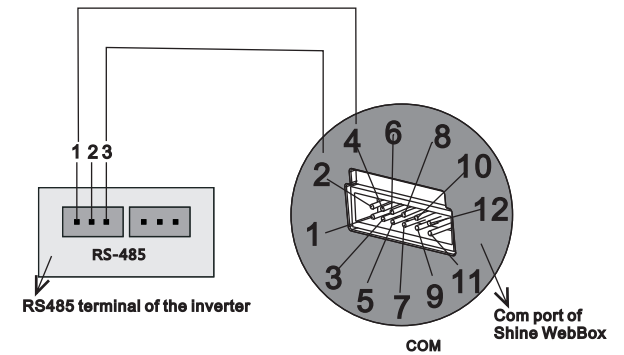

In most situations, the Inverter requires very little service. However, if Inverter is not able to work perfectly, please refer to the following instructions before calling your local dealer.

Should any problems arise, the LED on the front panel will be red and the LCD displays the relevant information. Please refer to the following for a list of potential problems and their solutions.

SYSTEM FAULT

Ground I Fault

1. The ground current is too high.
2. Unplug the inputs from the PV generator and check the peripheral AC system.
3. After the cause is cleared, re-plug the PV panel and check PV-Inverter status.
4. If the problem persists please call service.

Isolation Fault

1. Check the impedance is between PV (+) & PV (-) and the PV-Inverter is earthed. The impedance must be greater than 8M.
2. If the problem persists please call service.

Grid Fault

1. Wait for 5 minutes, if the grid returns to normal, PV-Inverter automatically restarts.
2. Make sure grid voltage and frequency meet the specifications.
3. If the problem persists please call service.
4. Check grid usability.

No AC connection

1. Grid is not connected.
2. Check grid connection cables.

INVERTER FAILURE

PV Over Voltage

1. Check the open PV voltage; see if it is greater than or too close to 500VDC.
2. If PV voltage is less than 500VDC, and the problem still occurs, please call local service.

Consistent Fault

1. Disconnect PV (+) or PV (-) from the input, restart the PV-Inverter.
2. If it does not work, call service.

If there is no display on the panel, please check PV-input connections. If the voltage is higher than 150V, call your local service.
During periods of little or no sunlight, the PV-Inverter may continuously start up and shut down. This is due to insufficient power generated to operate the control circuits.

	Growatt1000	Growatt1500	Growatt2000	Growatt3000
Input Data				
Max. DC power	1300W	1800W	2300W	3200W
Max. DC voltage	450V	450V	500V	500V
PV voltage range	70V-450V	100V-450V	100V-500V	100V-500V
MPP voltage range	110V-400V	175V-450V	195V-450V	250V-450V
Number of MPP trackers/ strings per MPP tracker	1 / 1	1 / 1	1 / 2	1 / 2
Max. input current /per string	10A/10A	10A/10A	12A/12A	15A/15A
Output Data				
Nominal AC output power	1000W	1600W	2000W	2850W
Max. AC power	1100W	1650W	2200W	3000W
Max. output current	5.5A	8A	11A	15A
AC nominal voltage; range	220,230,240V; 180Vac-280Vac	220,230,240V; 180Vac-280Vac	220,230,240V; 180Vac-280Vac	220,230,240V; 180Vac-280Vac
AC grid frequency ; range	50Hz,60Hz;±5Hz	50Hz,60Hz;±5Hz	50Hz,60Hz;±5Hz	50Hz,60Hz;±5Hz
Phase shift (cos φ)	1	1	1	1
THDI	< 3%	< 3%	< 3%	< 3%
AC connection	Single phase	Single phase	Single phase	Single phase
Efficiency				
Max. efficiency	97%	97%	97%	97%
Euro-eta	95.5%	96.5%	96.5%	96.5%
MPPT efficiency	99.5%	99.5%	99.5%	99.5%
Protection Devices				
DC reverse polarity protection	yes	yes	yes	yes
AC short-circuit protection	yes	yes	yes	yes
Ground fault monitoring	yes	yes	yes	yes
Grid monitoring	yes	yes	yes	yes
Integrated all-pole sensitive leakage current monitoring unit	yes	yes	yes	yes
General Data				
Dimensions (W / H / D) in mm	360/329/132	360/329/132	360/329/132	360/329/132
Weight	11.5 KG	11.5 KG	11.7 KG	12.2 KG
Operating temperature range	-25°C...+60°C	-25°C...+60°C	-25°C...+60°C	-25°C...+60°C
Continuous full output power temperature range	-25°C...+50°C	-25°C...+50°C	-25°C...+50°C	-25°C...+50°C
Noise emission (typical)	≤25 dB(A)	≤25 dB(A)	≤ 25 dB(A)	≤ 25 dB(A)
Consumption: operating (standby) / night	<5W /< 0.5 W	<5W /< 0.5 W	<5W /< 0.5 W	<5W /< 0.5 W
Topology	transformerless	transformerless	transformerless	transformerless
Cooling concept	No fan	No fan	No fan	No fan
Installation: Indoor/ Outdoors (IP65 electronics)	yes / yes	yes / yes	yes / yes	yes / yes
Certificates and Approvals				
CE, VDE 0126-1-1, G83/1-1, G59/2, Rd1663, En50438, VDE-AR-N4105, IEC-62109, ENEL-Guide(CEI 0-21+A70)				

	Growatt4000	Growatt4400	Growatt5000
Input Data			
Max. DC power	4200W	4600W	5000W/5200W *
Max. DC voltage	580V	580V	580V
PV voltage range	100V-580V	100V-580V	100V-580V
MPP voltage range	250V-500V	250V-500V	250V-500V
Number of MPP trackers/ strings per MPP tracker	1 / 3	1 / 3	1 / 3
Max. input current /per string	20A/20A	20A/20A	20A/20A
Output Data			
Nominal AC output power	3680W	4200W	4600W
Max. AC power	4000W	4400W	4600W/5000W *
Max. output current	16A	21A	22.7A
AC nominal voltage; range	220,230,240V; 180Vac-280Vac	220,230,240V; 180Vac-280Vac	220,230,240V; 180Vac-280Vac
AC grid frequency ; range	50Hz,60Hz;±5Hz	50Hz,60Hz;±5Hz	50Hz,60Hz;±5Hz
Phase shift (cos φ)	1	1	1
THDI	< 3%	< 3%	< 3%
AC connection	Single phase	Single phase	Single phase
Efficiency			
Max . efficiency	97.8%	97.8%	97.8%
Euro-eta	97.4%	97.4%	97.4%
MPPT efficiency	99.5%	99.5%	99.5%
Protection Devices			
DC reverse polarity protection	yes	yes	yes
AC short-circuit protection	yes	yes	yes
Ground fault monitoring	yes	yes	yes
Grid monitoring	yes	yes	yes
Integrated all-pole sensitive leakage current monitoring unit	yes	yes	yes
General Data			
Dimensions (W / H / D) in mm	406/406/192	406/406/192	406/406/192
Weight	21 KG	21KG	21 KG
Operating temperature range	-25°C...+60°C	-25°C...+60°C	-25°C...+60°C
Continuous full output power temperature range	-25°C...+50°C	-25°C...+50°C	-25°C...+50°C
Noise emission (typical)	≤25 dB(A)	≤ 25 dB(A)	≤ 25 dB(A)
Consumption: operating (standby) / night	<5W /< 0.5 W	<5W /< 0.5 W	<5W /< 0.5 W
Topology	transformerless	transformerless	transformerless
Cooling concept	No fan	No fan	No fan
Installation: Indoor/ Outdoors (IP65 electronics)	yes / yes	yes / yes	yes / yes
Certificates and Approvals			
	CE,VDE 0126-1-1,G83/1-1,G59/2,RD1663,EN50438,IEC-62109,ENEL-Guide		
	* Optionally provide 5000W		

	Sungold 1000	Sungold 1500	Sungold 2000
Input Data			
Max. DC power	1300W	1800W	2300W
Max. DC voltage	450V	450V	500V
PV voltage range	70V-450V	100V-450V	100V-500V
MPP voltage range	110V-450V	175V-450V	195V-450V
Number of MPP trackers/ strings per MPP tracker	1 / 1	1 / 1	1 / 2
Max. input current /per string	10A/10A	10A/10A	12A/12A
Output Data			
Nominal AC output power	1000W	1650W	2000W
Max. AC power	1100W	1650W	2200W
Max. output current	5.5A	8A	11A
AC nominal voltage;range	230V; 207Vac-263Vac	230V; 207Vac-263Vac	230V; 207Vac-263Vac
AC grid frequency ; range	50Hz,60Hz;±5Hz	50Hz,60Hz;±5Hz	50Hz,60Hz;±5Hz
Phase shift (cos φ)	1	1	1
THDI	< 3%	< 3%	< 3%
AC connection	Single phase	Single phase	Single phase
Efficiency			
Max . efficiency	97%	97%	97%
Euro-eta	95.5%	96.5%	96.5%
MPPT efficiency	99.5%	99.5%	99.5%
Protection Devices			
DC reverse polarity protection	yes	yes	yes
AC short-circuit protection	yes	yes	yes
Ground fault monitoring	yes	yes	yes
Grid monitoring	yes	yes	yes
Integrated all-pole sensitive leakage current monitoring unit	yes	yes	yes
General Data			
Dimensions (W / H / D) in mm	360/329/132	360/329/132	360/329/132
Weight	11.5 KG	11.5 KG	11.7 KG
Operating temperature range	-25°C...+60°C	-25°C...+60°C	-25°C...+60°C
Continuous full output power temperature range	-25°C...+50°C	-25°C...+50°C	-25°C...+50°C
Noise emission (typical)	≤ 25 dB(A)	≤ 25 dB(A)	≤ 25 dB(A)
Consumption: operating (standby) / night	<5W /< 0.5 W	<5W /< 0.5 W	<5W /< 0.5 W
Topology	transformerless	transformerless	transformerless
Cooling concept	No fan	No fan	No fan
Installation: Indoor/ Outdoors (IP65 electronics)	yes / yes	yes / yes	yes / yes
Certificates and Approvals			
	AS 4777, AS/NZS 3100		

	Sungold 3000	Sungold 4600	Sungold 5000
Input Data			
Max. DC power	3200W	4800W	5200W
Max. DC voltage	500V	580V	580V
PV voltage range	100V-500V	100V-580V	100V-580V
MPP voltage range	250V-450V	250V-500V	250V-500V
Number of MPP trackers/ strings per MPP tracker	1 / 2	1 / 3	1 / 3
Max. input current /per string	15A/15A	20A/20A	20A/20A
Output Data			
Nominal AC output power	2850W	4600W	5000W
Max. AC power	3000W	4600W	5000W
Max. output current	15A	23A	25A
AC nominal voltage;range	230V; 207Vac~263Vac	230V; 207Vac~263Vac	230V; 207Vac~263Vac
AC grid frequency ; range	50Hz,60Hz;±5Hz	50Hz,60Hz;±5Hz	50Hz,60Hz;±5Hz
Phase shift (cos φ)	1	1	1
THDI	< 3%	< 3%	< 3%
AC connection	Single phase	Single phase	Single phase
Efficiency			
Max . efficiency	97%	97.8%	97.8%
Euro-eta	96.5%	97.4%	97.4%
MPPT efficiency	99.5%	99.5%	99.5%
Protection Devices			
DC reverse polarity protection	yes	yes	yes
AC short-circuit protection	yes	yes	yes
Ground fault monitoring	yes	yes	yes
Grid monitoring	yes	yes	yes
Integrated all-pole sensitive leakage current monitoring unit	yes	yes	yes
General Data			
Dimensions (W / H / D) in mm	360/329/132	406/406/192	406/406/192
Weight	12.2 KG	21 KG	21 KG
Operating temperature range	-25°C...+60°C	-25°C...+60°C	-25°C...+60°C
Continuous full output power temperature range	-25°C...+50°C	-25°C...+50°C	-25°C...+50°C
Noise emission (typical)	≤ 25 dB(A)	≤ 25 dB(A)	≤ 25 dB(A)
Consumption: operating (standby) / night	<5W /< 0.5 W	<5W /< 0.5 W	<5W /< 0.5 W
Topology	transformerless	transformerless	transformerless
Cooling concept	No fan	No fan	No fan
Installation: Indoor/ Outdoors (IP65 electronics)	yes / yes	yes / yes	yes / yes
Certificates and Approvals			
AS 4777, AS/NZS 3100			